

ZW series

HITACHI

ZW
220



WHEEL LOADER

- **Model Code** : ZW220
- **Operating Weight** : 17 010 - 17 560 kg
- **Bucket Capacity** : ISO Heaped : 2.7-3.4 m³
- **Max. Engine Output** : 164 kW (220 HP)

Introducing the New-Generation Wheel Loaders:

ZW Series

Top-Class Production with Amazing Mobility

The new ZW Series wheel loaders are packed with numerous innovative technologies and mechanisms. Total control of engine and pump torque is an industry's first.

Three work modes and three driving modes help enhance operating ease and yield high production. What's more, lots of advanced designs give power and speed for loading and travel.

The ZW Series will set a new standard of productive, easy-to-operate wheel loaders.

Productivity

Three work modes to increase production and decrease fuel consumption

Three driving modes for optimum speed shift

Automatic transmission with load-sensing system

High-torque engine and capacious torque converter

Torque proportioning differential

Limited slip differential (Optional)

Smoother simultaneous operations with advanced hydraulic circuit

Selectable clutch cutoff Timing

Lift arm auto leveler (Optional)

Ride control system (Optional)

Page 4-7

Panoramic comfortable cab

Bi-level auto air conditioner and pressurized cab

Front & rear defrosters

Low noise design

Panoramic cab

Enhanced upward visibility

Good rear visibility

Ergonomically positioned switches and controls

Down-Shift Switch (DSS) and

Up-Shift Switch (USS)

Multi-functional joystick lever (Optional)

Comfort-designed suspension seat

Page 8-9

Enhanced Durability

Robust differential gears

Robust drive system

Durable axles

Variable displacement pumps

Robust frame

Hydraulically operated cooling fan with heat-sensing system

Capacious hydraulic oil cooler

Protected fuel tank

Aluminum radiator and oil cooler

LED indicators and instruments

O-Ring Seal (ORS) joints and water-

resistant electric connectors

Page 10-11

Easy Maintenance

Extended hydraulic oil replacement intervals

Easy draining

Conveniently located filters

Easy-to-replace air conditioning filters

HN bushings

Strategically located Fuel supply port

Large tool box

Easy-to-read monitor

Flat cab floor

Hinged radiator cover

Dirt-Less (DL) front frame

Page 12-13

Safety

Full fan guard

Emergency steering system (Optional)

Mis-operation protection

ROPS / FOPS cab

Highly reliable dual-line brake system

Other safety features

Page 14

Environment

Common rail fuel injection system

Cooled Exhaust Gas Recirculation (EGR) system

Hitachi Silent (HS) fan

Low noise engine

A recyclable machine

Page 15

Specifications

Page 16-19

- The new engine complies with the Emission Regulations U.S EPA Tier 3 and EU Stage III A
- The advanced low noise design complies with the coming EU noise regulation 2000 / 14 / EC, STAGE II



Note : Pictures may or may not include standard and optional equipment that are specified individually by countries.

Packed with Numerous Technological Advances for Amazing Mobility and Big Production

The new ZW Series is packed with lots of technological advances: the TT* system, newly developed hydraulic system and transmission, well matching of operations, impressive mobility and big production with less fuel consumption, and much more.

*Total Torque-control

Three Work Modes to Increase Production and Decrease Fuel Consumption

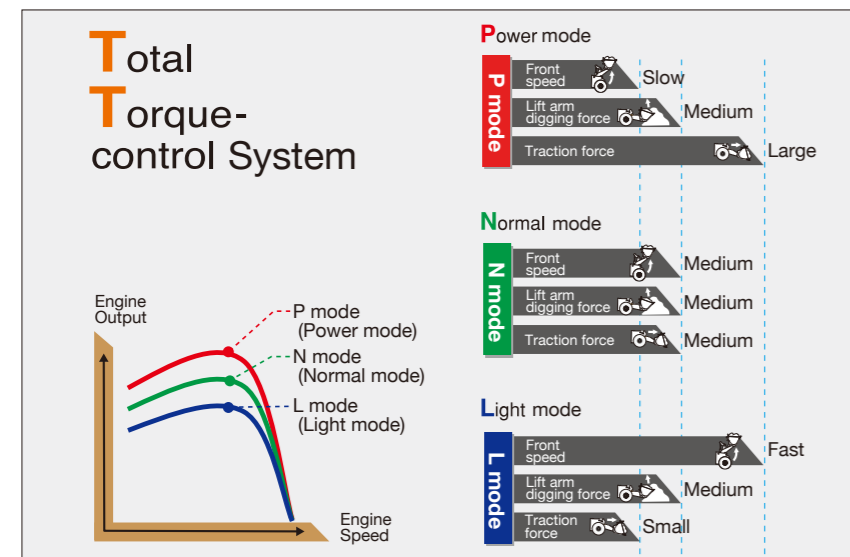

Three work modes are selectable according to job needs and operator's preference. In each work mode, TT* system controls the total torque of the engine and pump for well matched penetration force and implement speed according to job needs. The three work modes can be optimally selected to suit materials to be handled for higher production.

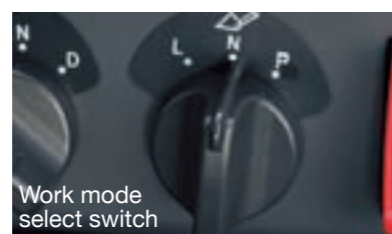

Work mode select switch
P mode: Heavy-duty excavation
N mode: Loading
L mode: Light-duty operation

Three Driving Modes for Optimum Speed Shift

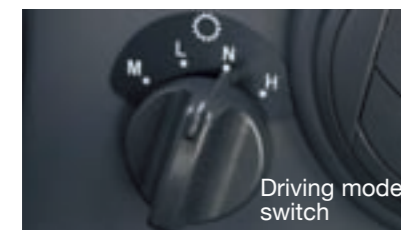

The three driving modes can be selected according to job needs and operator's preference.

L mode :
 Starts with the second gear, and makes gear shift at fast timing. Suitable for long-distance travel on level ground.

N mode :
 Starts with the second gear and makes gear shift at slow timing. Suitable for ordinary digging and loading operation such as V-shaped load and carry method.

H mode :
 Makes gear shift at timing similar to the N mode, and automatically shifts down to the first gear according to loading conditions without need for shift down by DSS* or manual shifting.

*Down-Shift Switch



Automatic Transmission with Load-Sensing System

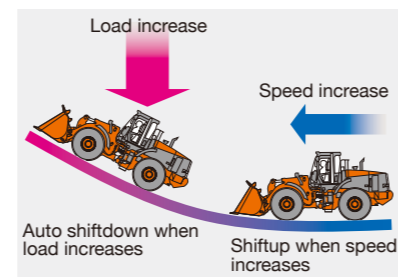

Optimal speed shift timing is automatically selected in response to both travel speed and load.

Smooth Speed Shift by Electronic Control

Quick, smooth speed shift can automatically be done with less shocks by electronic control through helical gears. This allows speedy job-to-job travel with less soil spills in load-and-carry operation.

High-Torque Engine and Capacious Torque Converter

Max. output : 164 kW (220 HP)
 Rated output : 139 kW (187 HP)
 Max. torque : 981 Nm (100 kgf m)

The new engine yields big torque at a low speed in direct response to acceleration without need for full throttle. The capacious torque converter enables powerful travel under heavy load, such as climbing steep or long hills without losing speed.

Torque Proportional Differential (Standard)

The torque proportional differential adjusts driving forces to both wheels. When road resistances under both wheels are different, this feature prevents slippage of a wheel on softer ground, unlike conventional differentials. This feature enables the ZW series to get out of swamps or rough terrain easily.

Limited Slip Differential (Optional)

On snowy roads and rough terrain, the limited slip differential can work instead of the torque proportional differential. This delivers effective driving force to both wheels for enhanced grip and less slippage during travel.

An Array of Elaborate Mechanisms for Impressive Mobility and Big Production

Improved Rise / Run Performance

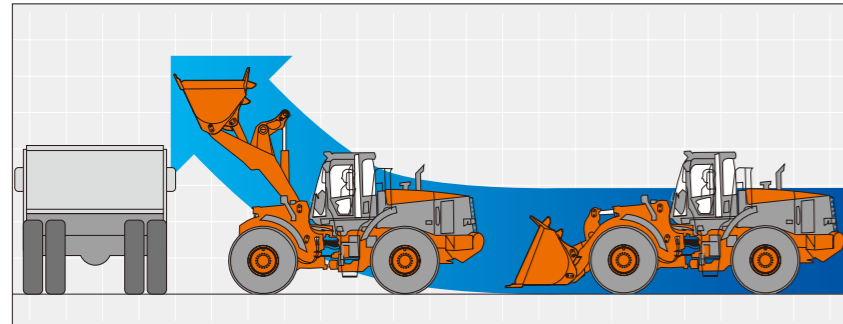

Arm rising while traveling for improved rise / run performance. On the new ZW Series, 10% higher rise/run performance can be expected, boosting loading efficiency and increasing productivity.

Smoother Simultaneous Operations with Advanced Hydraulic Circuit



With the new parallel/tandem circuits, the lift arm and bucket can be operated at the same time, unlike conventional machines. This can remarkably increase digging and loading efficiency for higher production.

Selectable Clutch Cutoff Timing

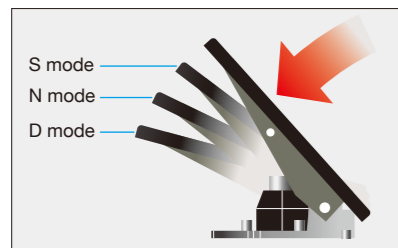

Clutch cutoff timing can be selected from three positions to suit various job conditions, including rapid operation on level ground, and surefooted operation on gradient.

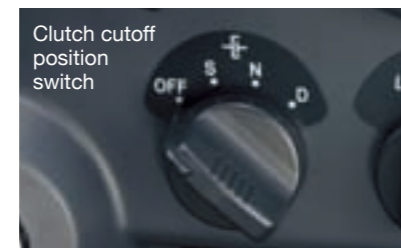

S mode :

The clutch is cutoff at fast timing by depressing the pedal for speedy loading on level ground.

N mode :

The clutch is cutoff by depressing the pedal midway for surefooted loading on slope.

D mode :

The clutch is cutoff by depressing the pedal fully for dumping into a hopper on slope.

OFF :

The clutch is disabled.

Sophisticated Mechanisms for Higher Job Efficiency

Float System

The float system lets the lift arm follow up road irregularities by using its self-weight only, without using its hydraulic circuit. This system is useful in soil-spill collecting during loading, and snow removing.

Bucket Auto Leveler

The bucket can automatically be leveled parallel to the ground after rolling the bucket out. This can eliminate cumbersome bucket repositioning for efficient loading.

Lift Arm Kick-Out System

The lift arm can automatically be raised up to the preset level. This function is convenient when loading onto a dump truck, and when operating at confined job sites with restricted working height.

Lift Arm Auto Leveler (Optional)

The lift arm can automatically be raised and lowered to the preset level. By using the switches in the cab, high and low lift kickouts can be programmed.

Operator-Friendly Designs for Higher Job Efficiency

Restriction Valve

The restriction valve can effectively reduce shocks when moving the lift arm up and down. The bucket does not have a shockless circuit to allow efficient mud removal.

Ride Control System (Optional)

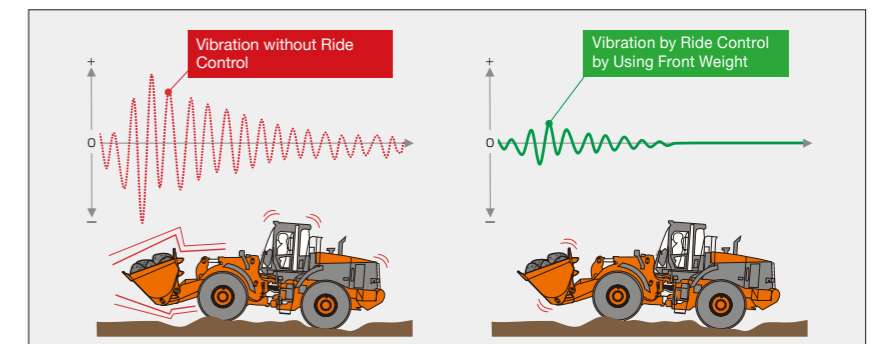

The ride control reduces pitching and bouncing during traveling on rough terrain and snow road by automatic control of the implement. Shocks and vibration can be well suppressed for riding comfort.





Operator-First Designs: Easy-to-Handle Controls for Operator Comfort

Panoramic Cab



The panoramic cab gives almost all-round visibility with the widened front glass window and pillar less cab rear corners. Front wheels are always in the operator's vision, enhancing safety and increasing loading efficiency.

Enhanced Upward Visibility

The front curved glass window gives good upward visibility, so the operator can directly see the movement of the bucket for safer loading.

Good Rear Visibility

The engine cover is low profile, and rounded for better rear visibility, so the operator can directly see the rear wheels and counterweight.

Comfort-Designed Suspension Seat



The mechanical suspension seat well absorbs shocks and vibrations from the machine body to reduce operator's physical stresses for enhanced comfort.

The air suspension seat is an option.

Bi-Level Auto Air Conditioner and Pressurized Cab



The bi-level air conditioner allows air conditioning at foot space and overhead simultaneously. Airflow volume and direction can automatically be adjusted according to the temperature setting. The pressurized cab shuts out dust and debris even in dusty environment.

Front / Rear Defrosters



With the front and rear defrosters, airflow comes out from three front air outlets and two rear outlets to protect respective windows from fogging, keeping clear vision even in rain and cold weather.

Shock-Dampened Cab

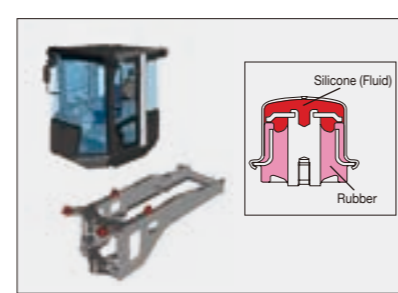

The cab rests on fluid-filled elastic mounts to absorb shocks and vibration, and reduce resonance.

Low Noise Design

The cab is well sealed, and the new low-noise engine is utilized to reduce sound, along with the following measures:

- Hydraulically operated cooling fan with heat-sensing system
- New Hitachi Silent (HS) fan
- Sound-absorbing materials inside engine cover and cab
- Clever arrangement of hydraulic oil tank and bulkhead

Ergonomically Positioned Switches and Controls



Switches and controls are efficiently laid out in the right console for ease of operation.

Down-Shift Switch (DSS) and Up-Shift Switch (USS)

DSS and USS are designed for one-gear down-shift and up-shift at the touch of a button.

An Array of Standard Accessories

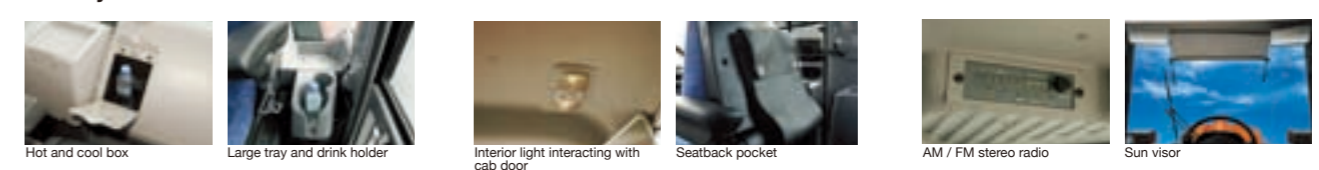

Hat (Resin Cab Roof)

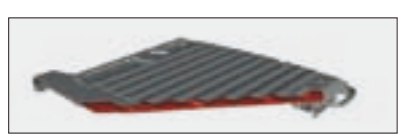

The hollow hat is provided atop the cab to form an air space. This greatly helps reduce the temperature rise in the cab, and increases the cooling efficiency of the air conditioner.

Enhanced Durability

Durability is enhanced with a number of advanced mechanisms for long, continuous operation.

Dependable Drive System

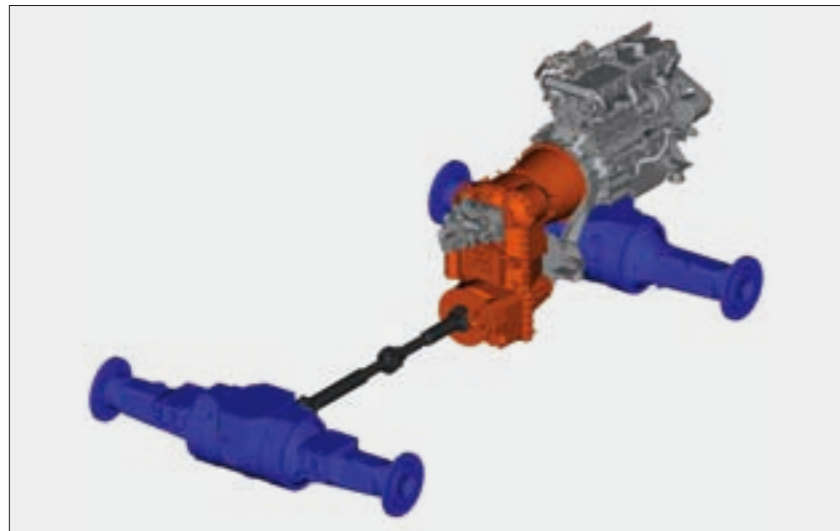

Transmission
The transmission can effectively reduce the transmitting load. This helps reduce sound and extend service life, enhancing reliability.

Robust Differential Gears
Differential gears are thickened to increase rigidity.

Robust Drive System
The new OHC 4-valve per cylinders engine is teamed up with strengthened cylinder head, block, crank and journal pins, and a lattice frame.

Durable Axles
Front and rear axles are improved for durability. The axle housing is thickened for tough operation at quarries.

Improved Braking Ability
The brake is a wet-type multi-plate brake, and housed in the axle.

Variable Displacement Pumps
New variable displacement pumps are exclusively developed and designed for Hitachi wheel loaders for tough earthmoving.

Robust Frame

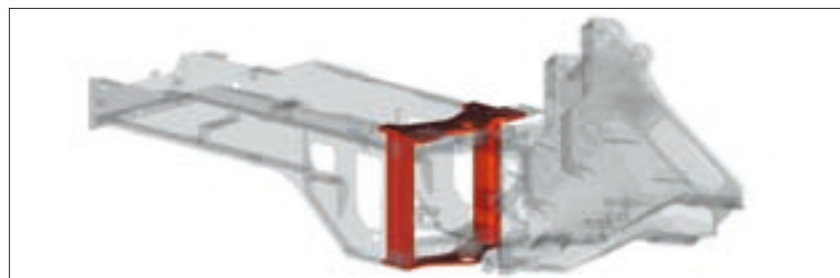

The box-section frame is thickened and strengthened to resist torsion and increase durability. Center pins are widely spaced for higher resistance to torsion.

Hydraulically Operated Cooling Fan with Heat-Sensing System



Fan speed can be adjusted depending on fluid temperature to effectively cool down coolant, hydraulic oil, transmission oil and torque converter oil. The result is extended component service life and reduction in fuel consumption. The fan is also separate from the engine for easy servicing.

Capacious Hydraulic Oil Cooler
The ample cooling capacity of the hydraulic oil cooler helps reduce oil temperature fluctuation, and extend service life of components.

Protected Fuel Tank



The large counterweight is arranged to protect the fuel tank from collisions with obstacles during operation.

Aluminum Radiator and Oil Cooler



The radiator and oil cooler are made of aluminum instead of conventional steel or copper for corrosion prevention.

LED Indicators and Instruments



On the indicators, monitors and alarms, many LEDs are utilized for longer service life resulting in less failure, enhancing the reliability.

O-Ring Seal (ORS) Joints and Water-Resistant Electric Connectors



Numerous elaborate components are utilized for higher durability and reliability. The proven ORS joints and high-pressure hydraulic lines are utilized in the hydraulic system, and water-resistant wiring connectors in the electrical system.



Reduced Running Costs

Running and maintenance costs are reduced greatly with concentrated inspecting points and durable components.



Extended Hydraulic Oil Replacement Intervals (Up from 2 000 to 4 000 Hours)

Hitachi genuine hydraulic oil can quadruple hydraulic oil replacement intervals. A hydraulic oil drain hose is mounted standard.

Extended Filter Replacement Intervals (250 to 500 Hours)

Filter replacement intervals are extended by increasing engine oil capacity and using high-performance filters, slashing servicing costs and downtime.

Easy Draining

The engine oil drain port is located for the convenience of maintenance. No need for reaching under the machine.

Conveniently Located Filters



Dual fuel filters with sedimentary function and engine oil filter are strategically located for the convenient daily inspection and servicing from the ground.

Easy-to-Replace Air Conditioning Filters



The fresh air filter can easily be replaced from the cab, and circulation air filter also replaced by detaching the drink holder.

HN Bushings



The HN bushing containing high-viscosity oil is provided at each joint to reduce grease consumption, extend lubrication intervals (100 to 500 hours), and increase durability.

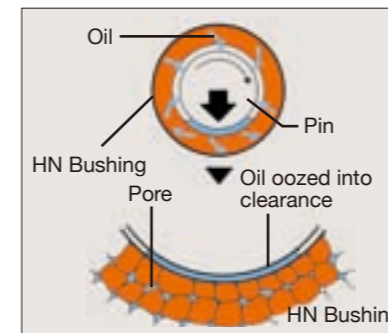

The HN bushing, another example of innovative technology developed by Hitachi, features long life and high durability. High-viscosity oil is vacuum impregnated in sintered high-hardness metal. During operation oil oozes from the pores of the bushing into the clearance between pins and bushing providing lubrication.

Strategically Located Fuel Supply Port



The fuel supply port is located for convenient fuel supply from the ground.

Large Tool Box



A large tool box is provided at the top step of the ladder on the right side of the machine. The tool box can hold a grease gun and tool kit.

Easy-to-Read Monitor



With the easy-to-read monitor, the operator can see instructions for scheduled servicing and maintenance.

Monitor Indication Items :

Clock, service intervals, travel speed, mileage, hour meter

Replacement Alerting : Engine oil / filter, fuel filter, hydraulic oil / filter, transmission oil / filter

Flat Cab Floor



The cab floor is stepless (flat) for ease of cleaning.

Reversible Hydraulically Operated Cooling Fan



The rotation of the hydraulically operated cooling fan with heat-sensing system can be reversed for easy removal of dirt from the radiator. The fan itself can swing open for easy cleaning.

Dirt-Less (DL) Front Frame



The DL front frame is shaped for easy removal of dirt, stones and snow.

Safety-First Design

Achieving a High-Level of Safety in the Working Environment with an Array of Advanced Mechanisms



ROPS / FOPS Cab

The ROPS / FOPS cab is provided to protect the operator from injury in an accident.

ROPS : Roll-Over Protective Structure : ISO3471

FOPS : Falling Object Protective Structure : ISO3449

Highly Reliable Dual-Line Brake System

The dual-line hydraulic brake system is utilized: even if one line fails, the other can work for braking. The brake is an enclosed wet multi-plate type for reliable braking.

Full Fan Guard



The cooling fan is enclosed by a full guard (metal net) to protect service technicians from injury during servicing and maintenance.

Emergency Steering System (Optional)

The emergency electric pump delivers the necessary oil pressure for power steering even in the case of an emergency. This allows normal steering at all times even if the engine fails.

Mis-Operation Protection:

Starting Engine : The engine will start only when the Forward / Reverse lever is in neutral.

Starting : The transmission is disabled when the parking switch is in the ON position, even if selecting Forward or Reverse.

Leaving from Operator Seat : Control levers and Forward / Reverse lever are locked to prevent accidental operation.

Stopping Engine : The spring-set/ hydraulic-released parking brake is automatically applied even if failing to apply it.

Other Safety Features



Retractable Seat Belt



Inclined Ladder

Environmentally Friendly Design

A Cleaner Machine

The ZW Series is equipped with a clean but powerful engine to comply with Tier 3 and Stage III A. An engine emission regulations effective in the U.S. EPA and European Union from 2006. Exhaust gas is partly re-combusted to reduce particulate matter (PM) output and lower nitrogen oxide (NOx) levels.

Common Rail Type Fuel Injection System

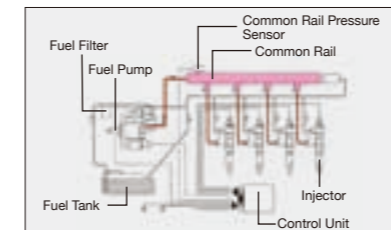

In this fuel injection system complying with the Emission Regulations, one fuel pump runs to generate high pressure for distributing fuel to each injector per cylinder through a common rail. By electronic control, fuel injection volume and timing can be precisely regulated for efficient combustion and higher horsepower. This also reduces PM* (diesel plume), fuel consumption and vibration.

*Particulate matter

Important: The use of fuels other than deisel fuel (JIS K-2204) (ASTM2-D) is prohibited. Otherwise, the engine may be damaged.

Cooled Exhaust Gas Recirculation (EGR) System

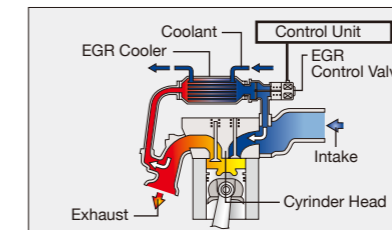

The cooled EGR system lets part of exhaust gasses mix with intake air for re-combustion to reduce oxygen concentration in the air in the combustion chamber. This design lowers combustion temperature in the cylinder, reducing fuel consumption and NOx while yielding more horsepower. This system also cools down exhaust gas to prevent incomplete combustion and PM* emission.

A Recyclable Machine



Approximately 95% of the ZW Series can be recycled. The resin parts are marked to facilitate recycling. The machine is completely lead-free. The radiator and oil cooler are made from aluminum and all wires are lead-less. In addition, bio-degradable hydraulic oil is available for jobsites where special environmental care is required.

A Quieter Machine

A number of features make this machine quieter. First, isochronous control of the engine speed means a restriction of engine speed during no-load and light-duty operation to suppress sound. A fan with curved blades reduces air resistance and airflow noise. Third, a time-tested muffler suppresses engine noise significantly and reduces emissions. This advanced low noise design complies with the 2000 / 14 / EC, Stage II, directive effective in the European Union from 2006.

Hitachi Silent (HS) Fan

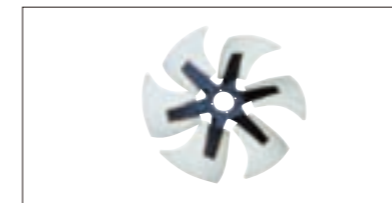

The HS fan is capable of reducing air resistance and air flow sound are utilized at the radiator and oil cooler for quieter operation.

Low Noise Engine

The cylinder block and ladder frame are strengthened to reduce engine sound.

SPECIFICATIONS

ENGINE

Model	Isuzu AH-6HK1
Type	4-cycle water-cooled, direct injection
Aspiration.....	Turbocharger and intercooled
No. of cylinders	6
Maximum power	
DIN 6272,	
Without Fan net.....	164 kW (223 PS) at 2 000 min ⁻¹ (rpm)
SAE J1349,	
Without Fan net.....	164 kW (220 HP) at 2 000 min ⁻¹ (rpm)
ISO 9249,	
Without Fan net.....	164 kW (220 HP) at 2 000 min ⁻¹ (rpm)
EEC 80/1269,	
Without Fan net.....	164 kW (220 HP) at 2 000 min ⁻¹ (rpm)
Bore and stroke.....	115 mm x 125 mm
Piston displacement....	7.790 L
Batteries.....	2 X 12 V / 916 CCA, 270-min. rated reserve
Air cleaner	Two element dry type with restriction indicator

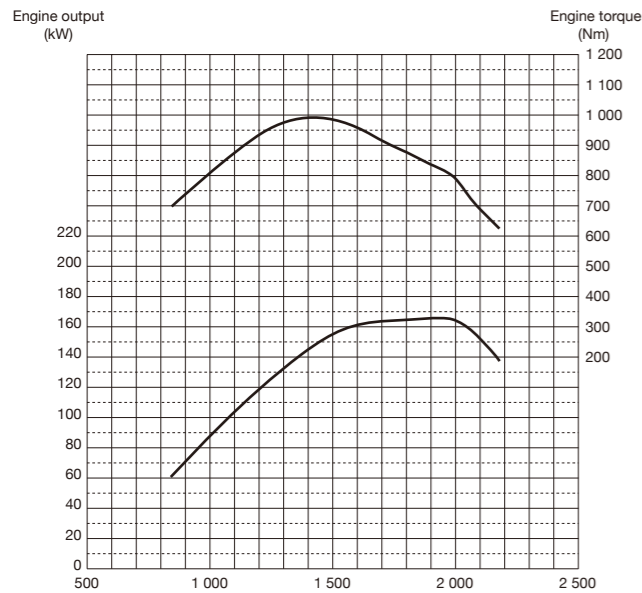

POWER TRAIN

Transmission	Torque converter, countershaft type powershift with computer-controlled automatic shift and manual shift features included.
Torque converter	Three element, single stage, single phase
Main clutch	Wet hydraulic, multi-disc type
Cooling method.....	Forced circulation type
Travel speed* (km/h)	Forward / Reverse
1st	7.0 / 7.1
2nd	12.0 / 12.6
3rd	23.0 / 23.8
4th	36.5 / -

*With 23.5-25-16 PR (L3) tires

AXLE AND FINAL DRIVE

Drive system	Four-wheel drive system
Front & rear axle.....	Semi-floating
Front	Fixed to the front frame
Rear	Trunnion support
Reduction and differential gear	Two stage reduction with torque proportional differential
Oscillation angle	Total 24 degree (+12 degree, -12 degree)
Final drives	Heavy-duty planetary, mounted inboard

TIRES (tubeless, nylon body)

Drive system	23.5-25-16 PR (L3)
Optional	Refer to standard & optional equipment list

BREAKS

Service brakes	Inboard mounted fully hydraulic 4 wheel wet disc brake. Front & rear independent brake circuit
----------------------	--

STEERING SYSTEM

Type	Articulated frame steering
Steering mechanism....	Refer to standard & optional equipment list
Steering angle	Each direction 40 degree ; total 80 degree
Cylinders	Two double-acting piston type
No. x Bore x Stroke....	2 x 70 mm x 442 mm
Minimum turning radius at the centerline of outside tire	5 620 mm

HYDRAULIC SYSTEM

Arm and bucket are controlled by independent control lever	
Arm controls.....	Four position valve ; Raise, hold, lower, float
Bucket controls with automatic bucket return-to-dig control ...	Three position valve ; Roll back, hold, dump
Main pump / Steering pump ..	Variable Displacement Axial Plunger Pump
Charging pump / Fan pump / Brake and assist pump	Fixed Displacement Type Gear Pump
Hydraulic cylinders	
Type	Two arm and one bucket, double acting type
No. x Bore x Stroke....	Arm : 2 x 130 mm x 880 mm Bucket : 1 x 165 mm x 510 mm
Filters	Full-flow 15 micron return filter in reservoir
Hydraulic cycle times	
Lift arm raise	5.6 s
Lift arm lower	3.5 s
Bucket dump	1.4 s
Total	10.5 s

SERVICE REFILL CAPACITIES

Fuel tank	270.0 L
Engine coolant	38.0 L
Engine oil	25.0 L
Torque convertor & transmission	36.0 L
Front axle differential & wheel hubs.....	32.0 L
Rear axle differential & wheel hubs	34.0 L
Hydraulic oil tank.....	114.0 L

EQUIPMENT

STANDARD EQUIPMENT

Standard equipment may vary by country, so please consult your Hitachi dealer for details.

ENGINE

- Coolant recovery tank
- Hydraulically Operated Cooling Fan with Heat Sensing System
- Fan guard
- Muffler, under hood with large exhaust stack
- Environmentally friendly engine oil drain
- Engine oil cooler
- Quick-release fuel filter and water separator
- Glow system (For cold start)
- Air filter double element
- Fuel double filter
- TT (Total Torque-control) system

POWER TRAIN

- Automatic Transmission with Load-Sensing System
- DSS (Down-Shift Switch) and USS (Up-Shift Switch)
- Torque proportioning differentials, front and rear
- Driving mode selector switch, three modes
- Clutch cut-off position switch, three position

HYDRAULIC SYSTEM

- TT (Total Torque-control) system
- Bucket auto leveler
- Lift arm kick-out system
- Float system
- Reservoir sight gauge
- Hydraulic filters, vertical mounting
- Two-spool main control valve
- O-Ring Seal joints

ELECTRICAL

- 24-volt electrical system
- Standard batteries (2), 12-volt with 916 CCA, 270-min. rated reserve
- Alternator, 50 A and 24-volts

- Lights
- Driving with guards / Turn signals with hazard switch / stop, tail and back-up lights
- Work lights on cab, front (2)
- Work lights, rear (2)
- Horn, with push button in center of steering wheel and switch on joystick lever knob or right console
- Reverse warning alarm
- Monitor and alarm system, multi-function electronic audible and visual warning include
- LCD monitor display: Speedometer / Clock / Hour-meter / Fuel consumption / Odometer / Replacement intervals / Transmission Auto / Clutch cutoff / Ride control / Gear shift
- Gauges: Engine coolant temperature / Transmission oil temperature / Fuel level
- Warning lights: Engine / Transmission / Discharge warning
- Indicator lights: Turn signals / High beam / Working lights / Service / Parking brake / Stop / Brake oil low pressure / Brake oil low level / Seat belt / Glow signal / Maintenance / Forward/Reverse switch / Water separator / Over heat / Engine oil low pressure / Air filter restriction / Transmission oil filter restriction / Hydraulic oil temperature / Transmission oil temperature
- 24-volt AM/FM stereo radio with clock

OPERATOR'S STATION

- Cab
- ROPS* / FOPS** / Multi-plane isolation mounted for noise / Vibration reduction / Front and rear windshield washers / Safety glass
- Adjustable armrest
- Bi-level auto air conditioner and pressurize cab
- Front / Rear defroster
- Hot and cool box
- Sun visor
- Seat(Grammer), fabric, high back, mechanical suspension, adjustable for weight-height, fore-aft

- position, backrest tilt, and armrest angle, seat cushion length and angle, lumber support
- Seatback pocket
- Retractable seat belt, 50 mm
- Large tray and drink holder
- Rubber floor mat
- Adjustable steering column
- Steering wheel, textured with spinner knob
- Rear view mirrors, outside (2) and inside (2)
- Handrails and steps, ergonomically located and slip resistant
- Coat hook

LOADER LINKAGE

- Z-bar loader linkage provides (High bucket breakout)

BUCKETS AND ATTACHMENTS

- Full line of Hitachi pin on buckets with selection of bolt-on cutting edges, and teeth-segmented bolt on edges
- General purpose bucket with bolt-on cutting edges : 3.2 m³ (ISO heaped)

TIRES

- Bias ply : 23.5-25-16 PR (L3)
- Multi-piece rims

OTHERS

- Fenders, front and rear
- Articulation locking bar
- Anti-vandal protection, includes lockable engine enclosure, and fuel fill
- Counterweight, built-in
- Drawbar, with rocking pin
- Lift and tie-down hooks
- Open type rear grill

OPTIONAL EQUIPMENT

Optional equipment may vary by country, so please consult your Hitachi dealer for details.

ENGINE

- Air pre-cleaner

POWER TRAIN

- Limited slip differential

HYDRAULIC SYSTEM

- Three-spool main control valve
- Four-spool main control valve
- Third spool piping
- Third and fourth spool piping
- Multi-function joystick lever
- Two-lever and auxiliary lever for third function
- Two-lever and auxiliary joystick-lever for third & fourth function
- Multi-function joystick lever and auxiliary lever for third function
- Multi-function joystick lever and auxiliary joystick-lever for third & fourth function
- Ride control system, automatic type
- Lift arm auto leveler

ELECTRICAL

- High-capacity batteries (2), 12-volt with 924 COCA, 421-min. rated reserve
- Alternator, high capacity, 90 A and 24-volt
- Front Working Lamps on Cab (2)
- Rear Working Lamp on Cab (2)
- 12-volt outlet
- 24-volt AM/FM stereo radio with cassette player and clock

- Installation kit for radio, fused 24-volt radio electrical lead, speaker (2), and antenna

OPERATOR'S STATION

- Seat(Grammer), fabric, high back, air suspension, seat heating, adjustable for weight-height, fore-aft position, backrest tilt, and armrest angle, seat cushion length and angle, headrest height and angle adjustment, lumber support
- Seat(Kab), fabric, high back, mechanical suspension, adjustable for weight-height, fore-aft position, backrest tilt, and armrest angle
- Headrest for Grammer seat
- Headrest for Kab seat
- Retractable seat belt, 76 mm
- Lever steering

LOADER LINKAGE

- High-lift arm

BUCKETS AND ATTACHMENTS

- General purpose bucket with bolt on teeth : 3.1 m³, 3.3 m³ (ISO heaped)
- General purpose bucket with bolt on cutting edge : 3.4 m³ (ISO heaped)
- Rock bucket with bolt on teeth : 2.7 m³ (ISO heaped)
- Quick coupler and hydraulic control system for quick coupler locking pins, includes all controls in the cab, lines, and valves
- Full line of Hitachi buckets for quick coupler with selection of bolt-on cutting edges, and bolt-on teeth

- Full line of construction utility forks, and attachments
- Fork : Pin on type
- Log grapple : Pin on type
- Fork grapple : Pin on type

TIRES

- Radial ply : 23.5R25 (L3)
23.5R25 (L4)
23.5R25 (L5)

OTHERS

- Bucket cylinder rod guard
- Auto lubrication system
- Heavy counterweight
- Additional counterweight (rear mount type)
- Bottom guards, front frame and transmission
- Full rear fender and mud guard
- Rear license plate bracket
- Biodegradable hydraulic oil
- Fire extinguisher (Dealer installed)
- Emergency steering system

Note : * : ROPS (Roll Over Protective Structure) Conforms to ISO 3471;1994
** : FOPS (Falling Objects Protective Structure) Conforms to ISO 3449; 1992 Level all

SPECIFICATIONS

DIMENSIONS & SPECIFICATIONS

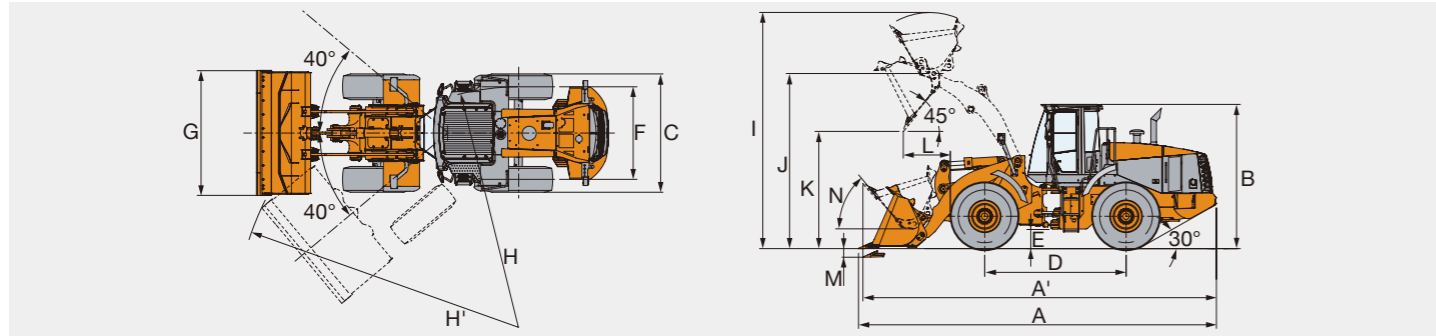

Bucket type		Standard Arm				High lift Arm			
		General purpose				Rock bucket	General purpose		
		With bolt-on teeth	With bolt-on cutting edges	With bolt-on teeth	With bolt-on cutting edges	With bolt-on teeth	With bolt-on cutting edges		
Bucket capacity	ISO heaped	m ³	3.1	3.2	3.3	3.4	2.7	2.7	
	ISO struck	m ³	2.6	2.8	2.8	2.9	2.3	2.3	
A Overall length		mm	8 345	8 200	8 390	8 245	8 290	8 575	
A' Overall length (Traveling figure)		mm	8 250	8 150	8 280	8 180	8 215	8 540	
B Overall height		mm						3 375	
C Width over tires		mm						2 785	
D Wheel base		mm						3 300	
E Ground clearance		mm						450	
F Tread		mm						2 160	
G Bucket width		mm						2 910	
H Turning radius (Centerline of outside tire)		mm						5 620	
H' Loader clearance circle, bucket in carry position		mm	6 640	6 600	6 650	6 620	6 630	6 770	
I Overall operating height		mm	5 470	5 470	5 520	5 520	5 480	5 750	
J Height to bucket hinge pin, fully raised		mm	4 090	4 090	4 090	4 090	4 090	4 500	
K Dumping clearance 45 degree, full height		mm	2 810	2 910	2 780	2 880	2 850	3 420	
L Reach, 45 degree dump, full height		mm	1 200	1 120	1 230	1 150	1 160	1 180	
M Digging depth (Horizontal digging angle)		mm	120	100	120	100	120	180	
N Max. roll back at carry position		deg						50	
Static tipping load *	Straight	kN	134	132	134	131	128	106	
		(kgf)	(13 700)	(13 450)	(13 650)	(13 400)	(13 050)	(10 800)	
	Full 40 degree turn	kN	116	114	116	113	110	91	
		(kgf)	(11 850)	(11 600)	(11 800)	(11 550)	(11 200)	(9 250)	
Breakout force		kN	169	156	163	150	178	152	
		(kgf)	(17 250)	(15 900)	(16 600)	(15 350)	(18 120)	(15 500)	
Operating weight *		kg	17 010	17 110	17 050	17 140	17 560	17 180	

Note:1. All dimensions, weight and performance data based on ISO 6746-1:1987, ISO 7137:1997 and ISO 7546:1983

2. Static tipping load and operating weight marked with* include 23.5-25-16PR (L3) tires (No ballast) with lubricants, full fuel tank and operator. Machine stability and operating weight depend on counterweight, tire size and other attachments.

BUCKET SELECTION GUIDE

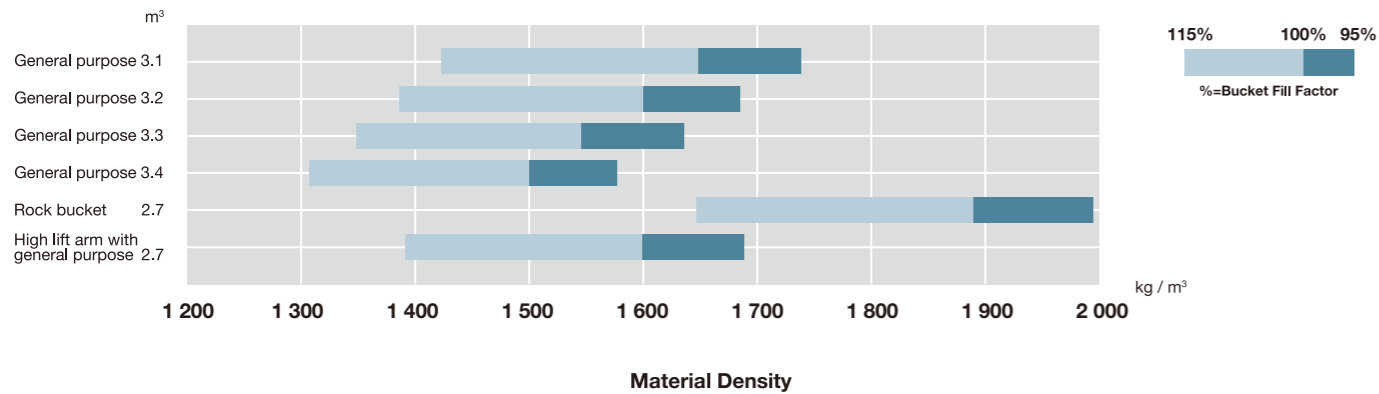

MEMO

These specifications are subject to change without notice.
Illustrations and photos show the standard models, and may or may not include optional equipment, accessories, and all standard equipment with some differences in color and features.
Before use, read and understand the Operator's Manual for proper operation.

